

FRONT ELEVATION

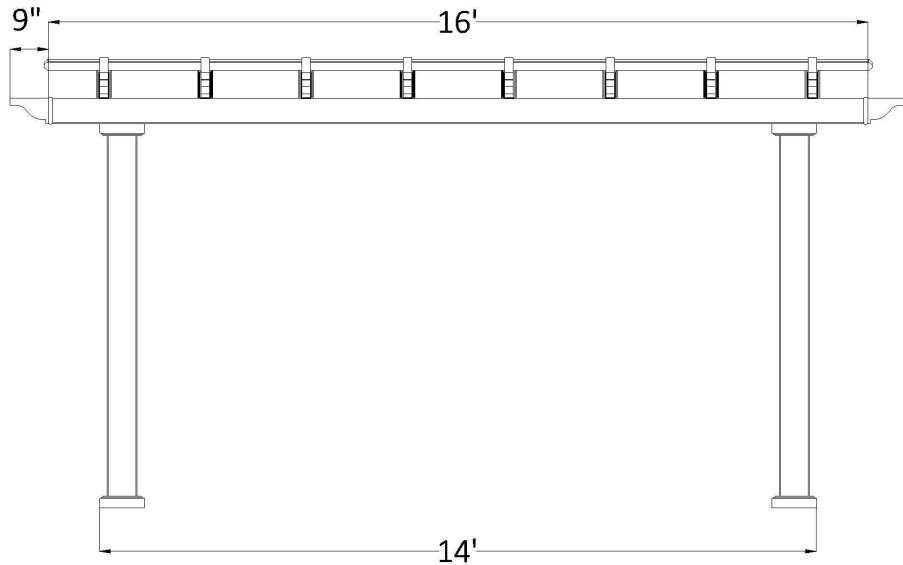

POST ON CENTER MEASUREMENT

POST STYLE	INCHES
5" Square Post (7" base)	163
7" Square Column (10 1/2" base)	157 1/2
7" Round Column (10 1/2" base)	157 1/2
10" Round Column (12 1/4" base)	155 3/4

SIDE ELEVATION

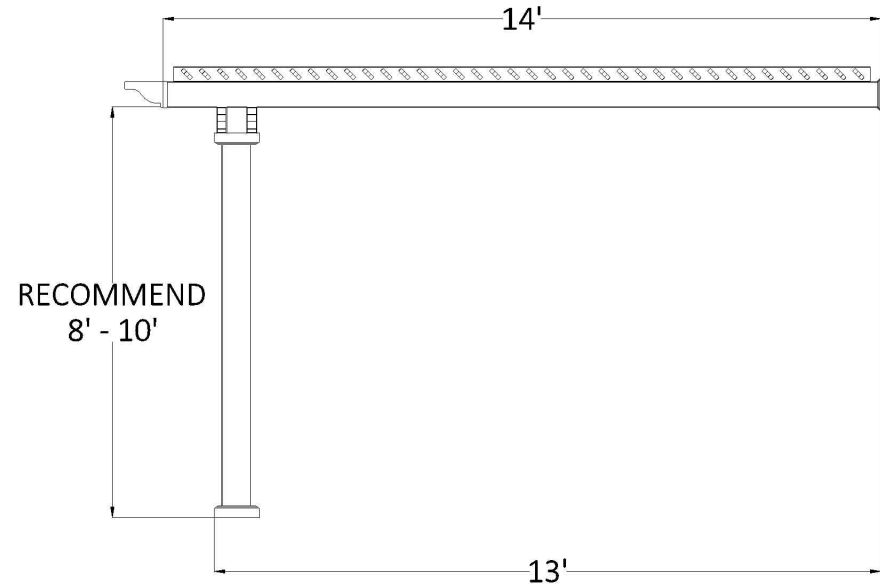

CENTER OF POST TO FACE OF LEDGER MEASUREMENT

POST STYLE	INCHES
5" Square Post (7" base)	153 1/2
7" Square Column (10 1/2" base)	150 3/4
7" Round Column (10 1/2" base)	150 3/4
10" Round Column (12 1/4" base)	149 7/8

PLAN VIEW

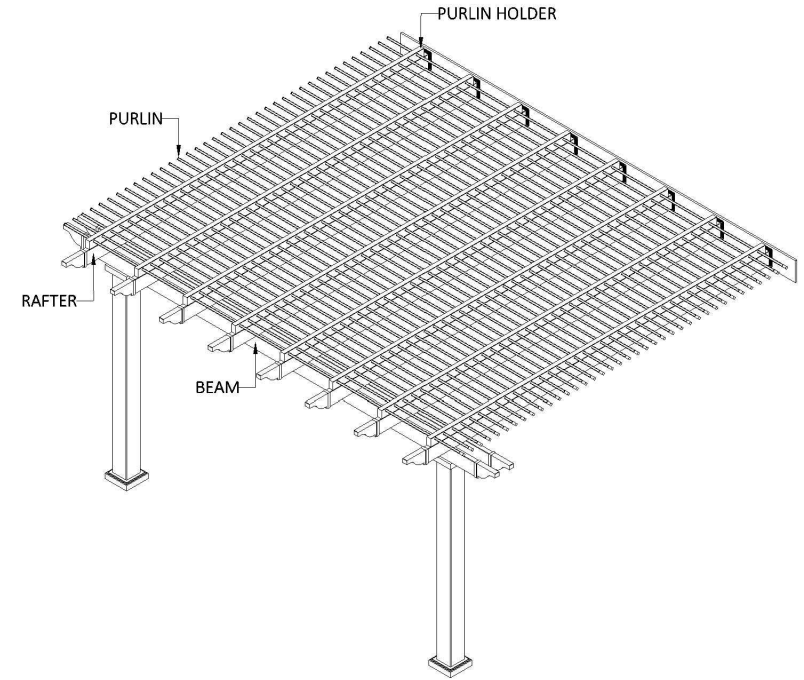
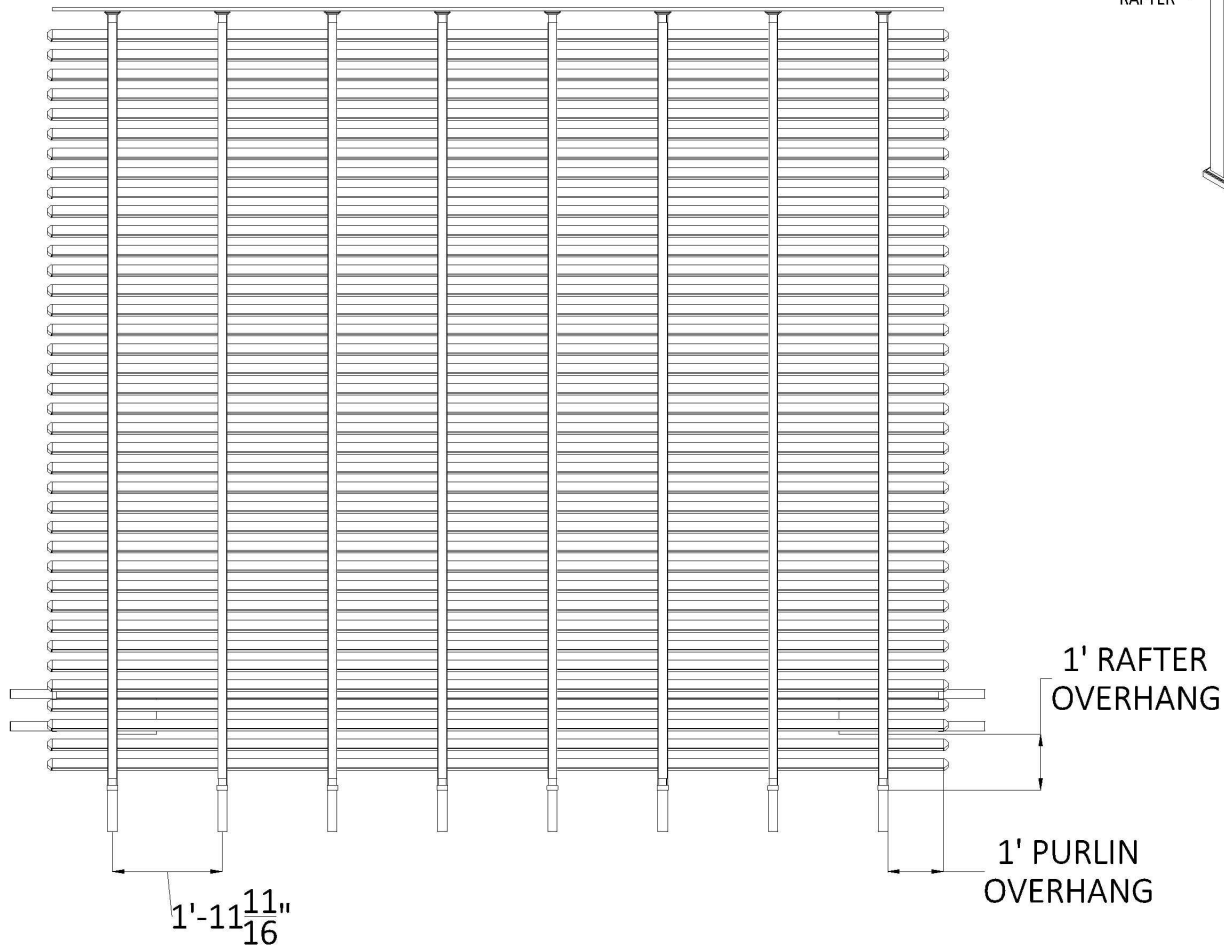

KIT COMPONENTS

DESCRIPTION	QUANTITY
Your Selected Post with Aluminum Insert	2
2 X 6 Beam with Aluminum Insert	2
2 X 6 Rafter with Aluminum Insert	8
2 X 6 Pergola Cap	12
2 X 3 1/2 Purlin Holder	8
2 X 3 1/2 Flat Cap	16
7/8 X 3 Purlin (75% Shade)	40
7/8 X 3 Purlin Cap	80
PVC Ledger Plate	1