

FRONT ELEVATION

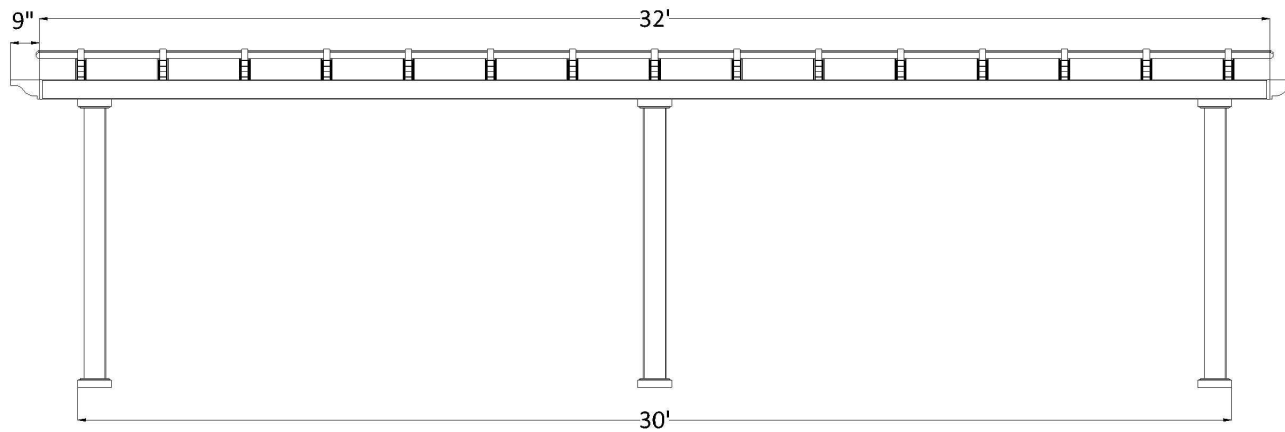

SIDE ELEVATION

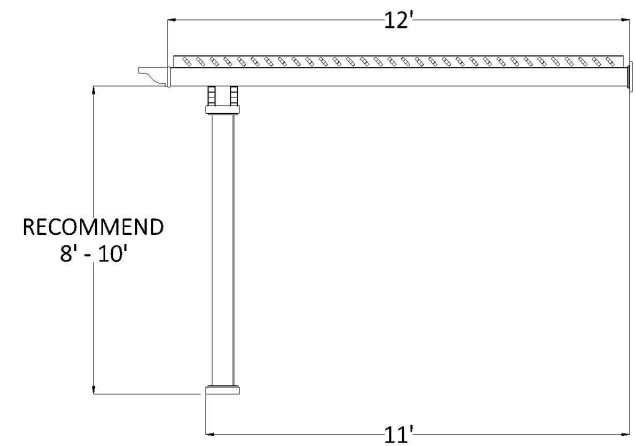

POST ON CENTER MEASUREMENT

POST STYLE	INCHES
5" Square Post (7" base)	177 1/2
7" Square Column (10 1/2" base)	174 3/4
7" Round Column (10 1/2" base)	174 3/4
10" Round Column (12 1/4" base)	173 7/8

CENTER OF POST TO FACE OF LEDGER MEASUREMENT

POST STYLE	INCHES
5" Square Post (7" base)	129 1/2
7" Square Column (10 1/2" base)	126 3/4
7" Round Column (10 1/2" base)	126 3/4
10" Round Column (12 1/4" base)	125 7/8

PLAN VIEW

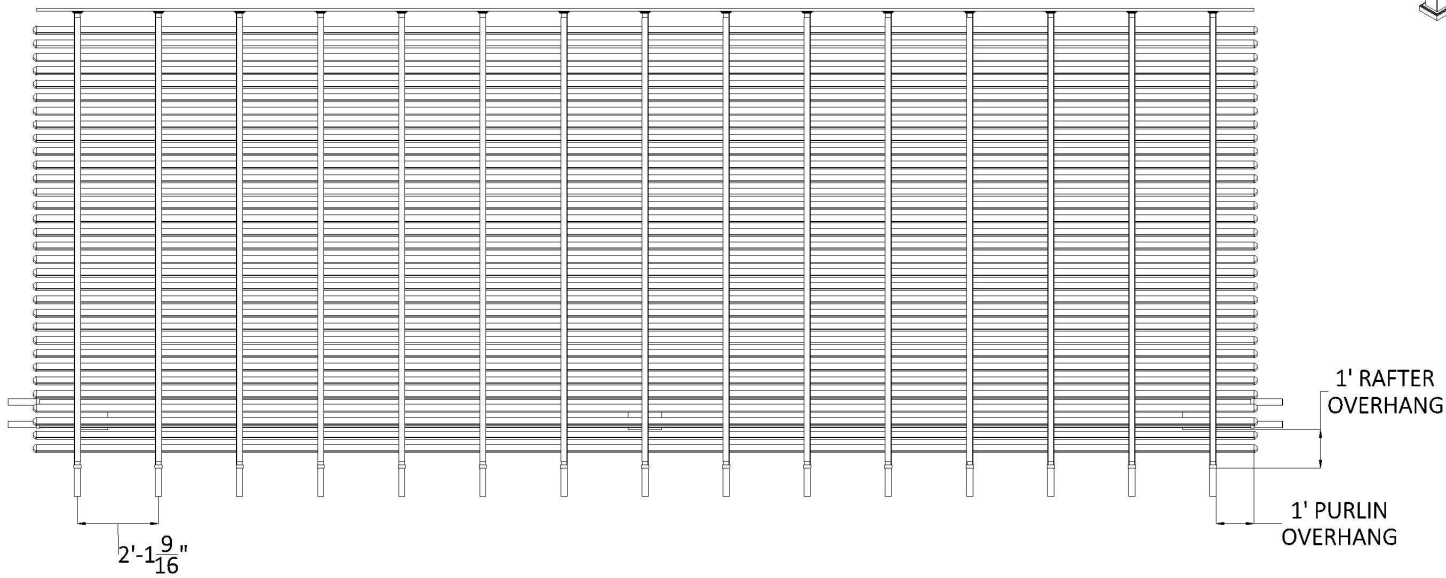
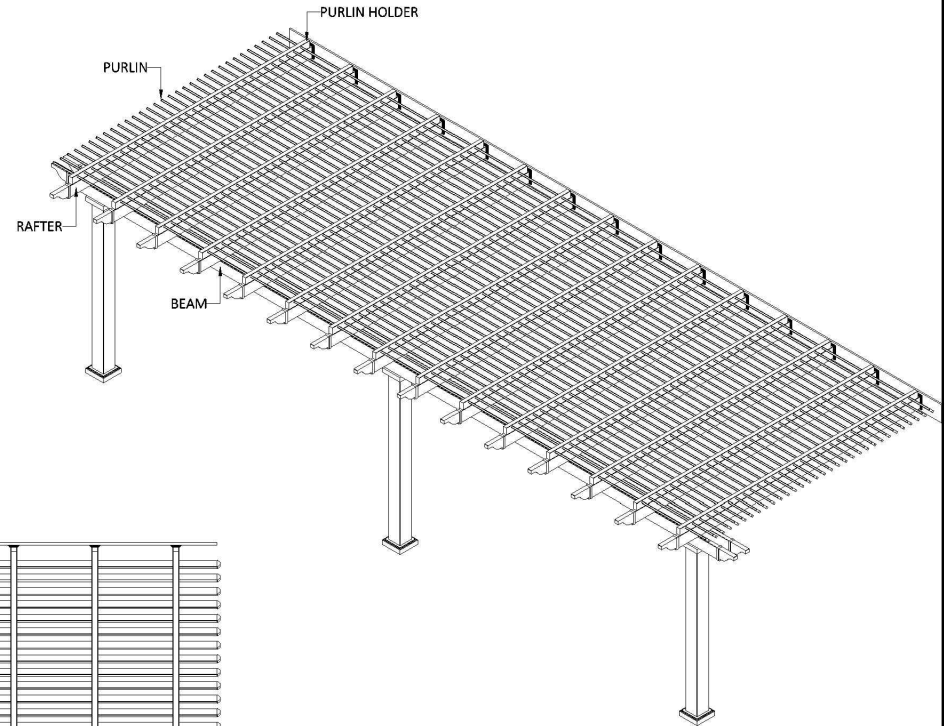

KIT COMPONENTS

DESCRIPTION	QUANTITY
Your Selected Post with Aluminum Insert	3
2 X 6 Beam with Aluminum Insert	4
2 X 6 Rafter with Aluminum Insert	15
2 X 6 Pergola Cap	19
2 X 3 1/2 Purlin Holder	15
2 X 3 1/2 Flat Cap	30
7/8 X 3 Purlin (75% Shade)	34
7/8 X 3 Purlin Cap	68
PVC Ledger Plate	1