

FRONT ELEVATION

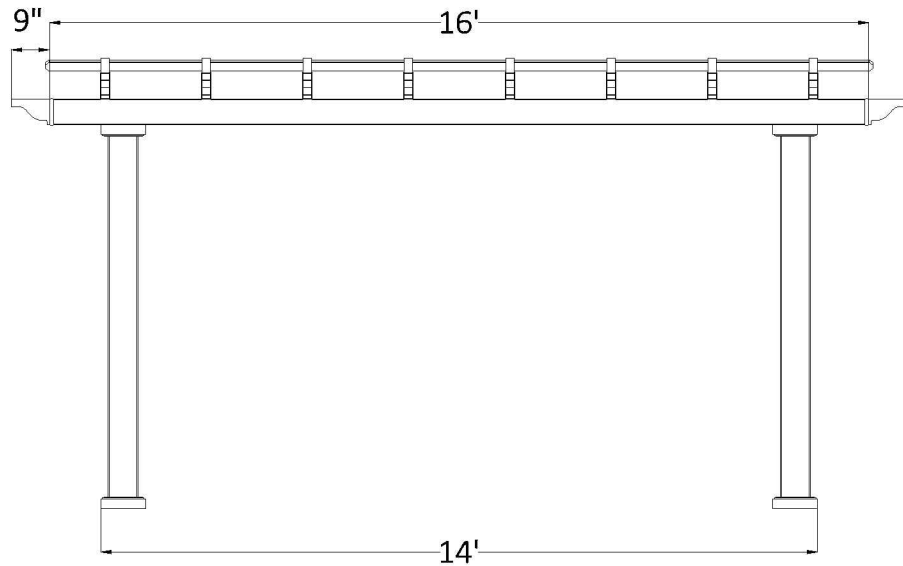

POST ON CENTER MEASUREMENT

POST STYLE	INCHES
5" Square Post (7" base)	163
7" Square Column (10 1/2" base)	157 1/2
7" Round Column (10 1/2" base)	157 1/2
10" Round Column (12 1/4" base)	155 3/4

SIDE ELEVATION

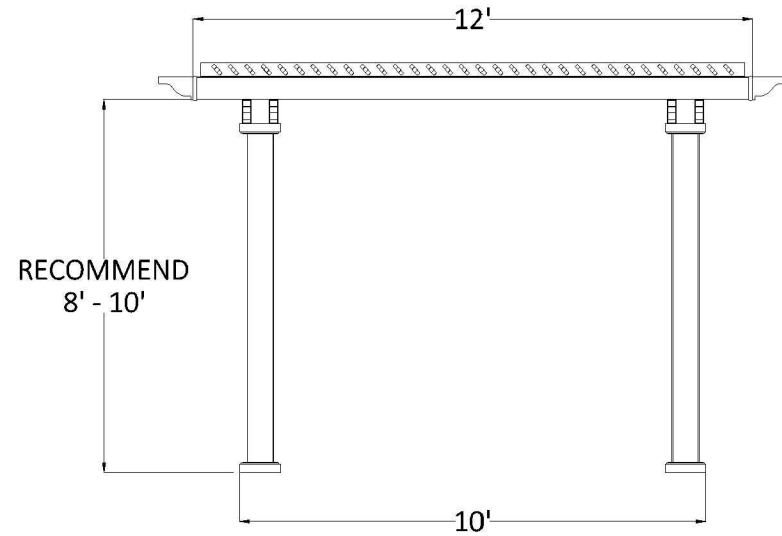

POST ON CENTER MEASUREMENT

POST STYLE	INCHES
5" Square Post (7" base)	115
7" Square Column (10 1/2" base)	109 1/2
7" Round Column (10 1/2" base)	109 1/2
10" Round Column (12 1/4" base)	107 3/4

PLAN VIEW

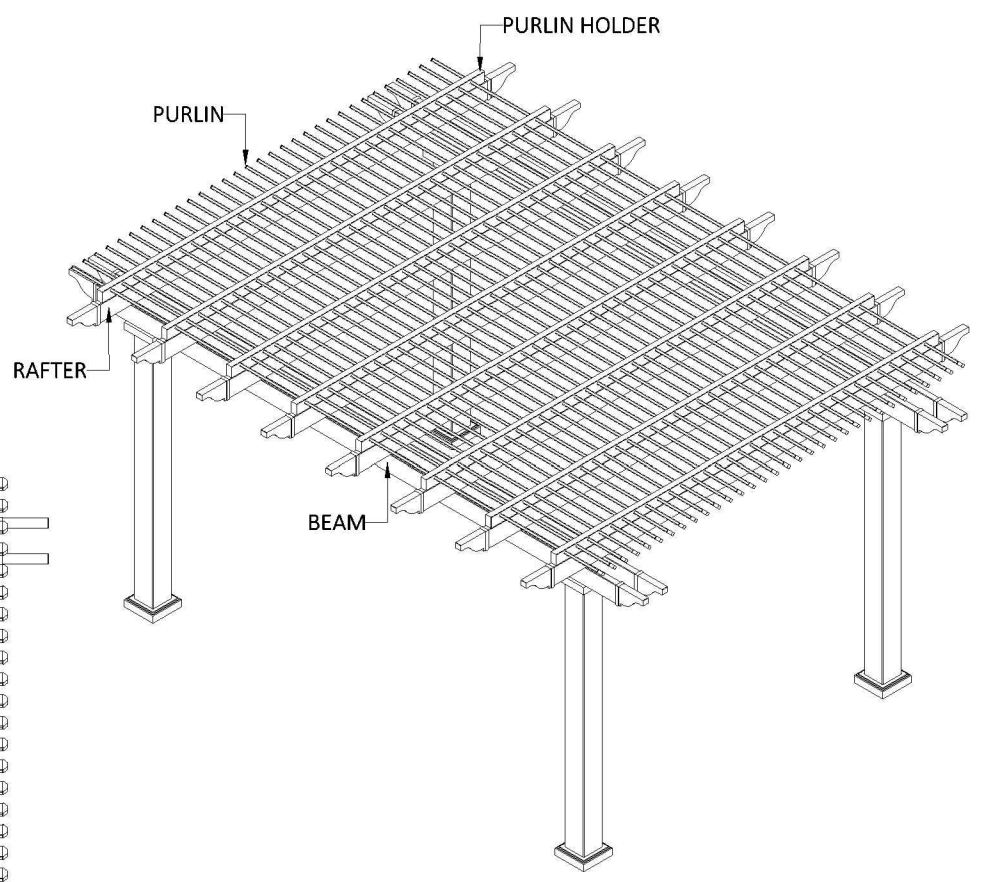
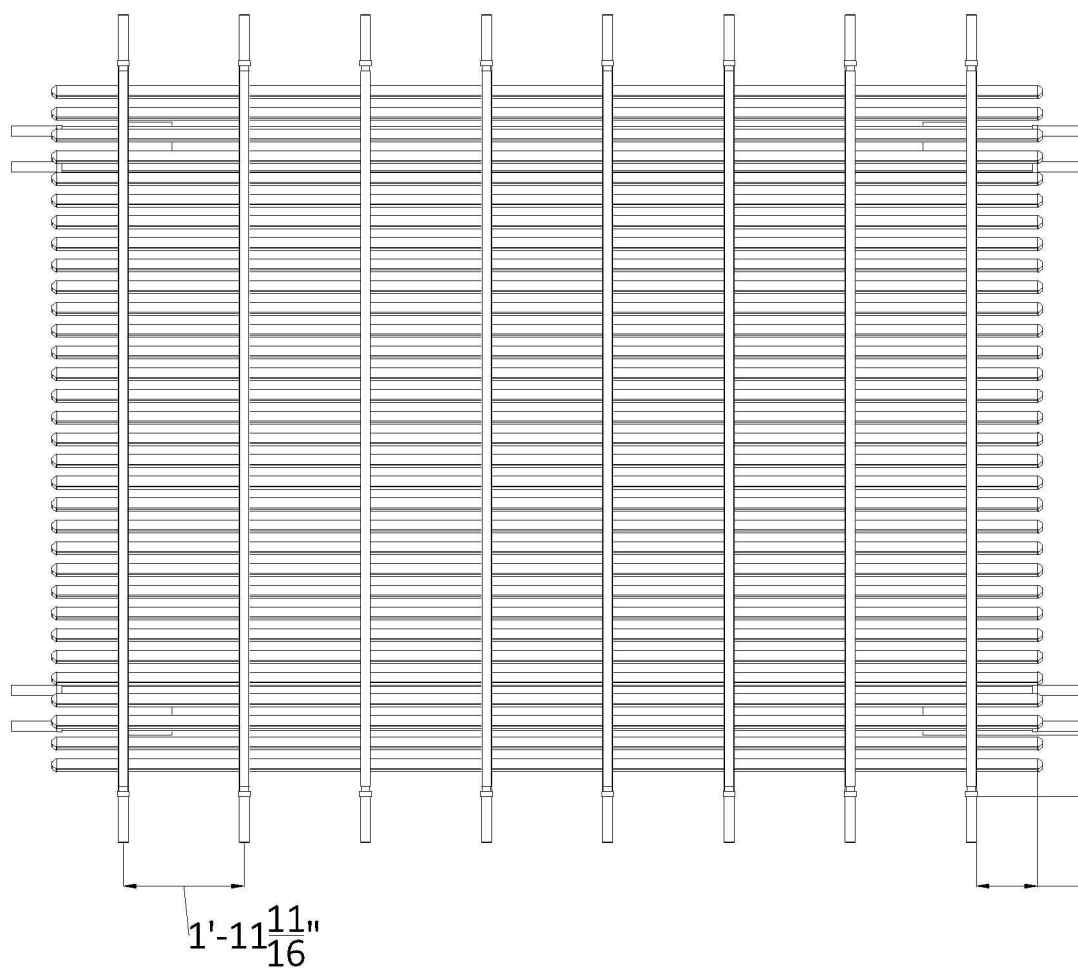

1' RAFTER OVERHANG

1' PURLIN OVERHANG

KIT COMPONENTS

DESCRIPTION	QUANTITY
Your Selected Post with Aluminum Insert	4
2 X 6 Beam with Aluminum Insert	4
2 X 6 Rafter with Aluminum Insert	8
2 X 6 Pergola Cap	24
2 X 3 1/2 Purlin Holder	8
2 X 3 1/2 Flat Cap	16
7/8 X 3 Purlin (75% Shade)	34
7/8 X 3 Purlin Cap	68