

FRONT ELEVATION

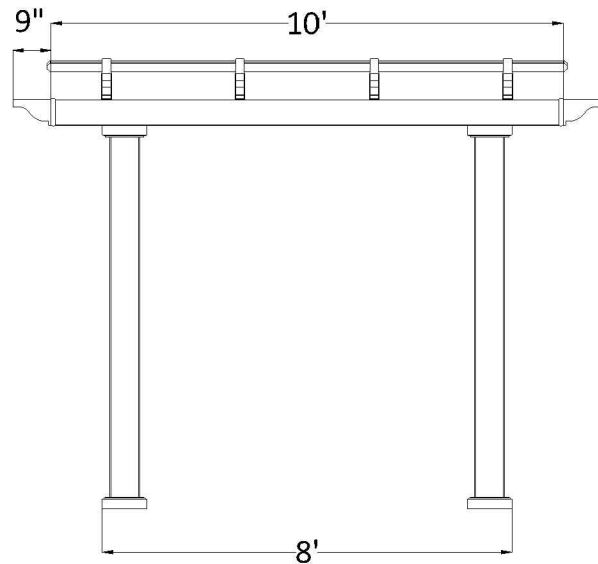

POST ON CENTER MEASUREMENT

POST STYLE	INCHES
5" Square Post (7" base)	91
7" Square Column (10 1/2" base)	85 1/2
7" Round Column (10 1/2" base)	85 1/2
10" Round Column (12 1/4" base)	83 3/4

SIDE ELEVATION

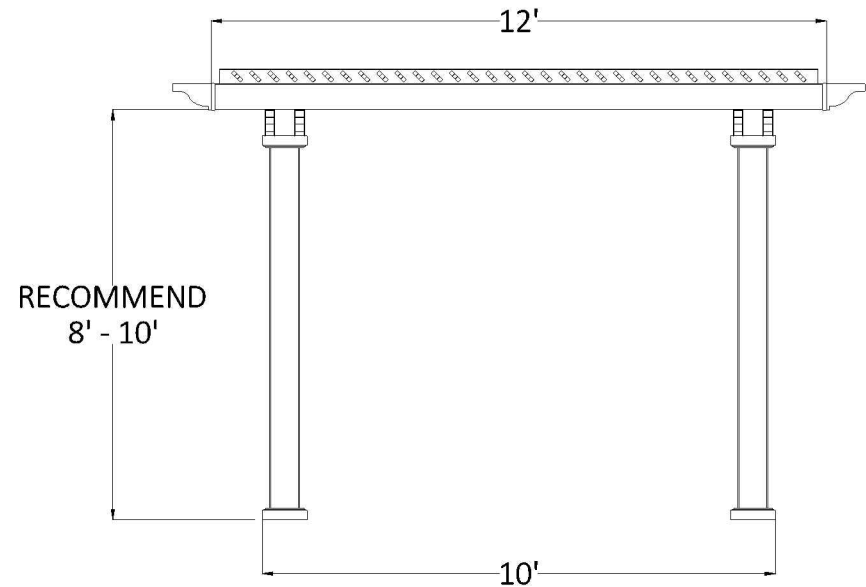

POST ON CENTER MEASUREMENT

POST STYLE	INCHES
5" Square Post (7" base)	115
7" Square Column (10 1/2" base)	109 1/2
7" Round Column (10 1/2" base)	109 1/2
10" Round Column (12 1/4" base)	107 3/4

PLAN VIEW

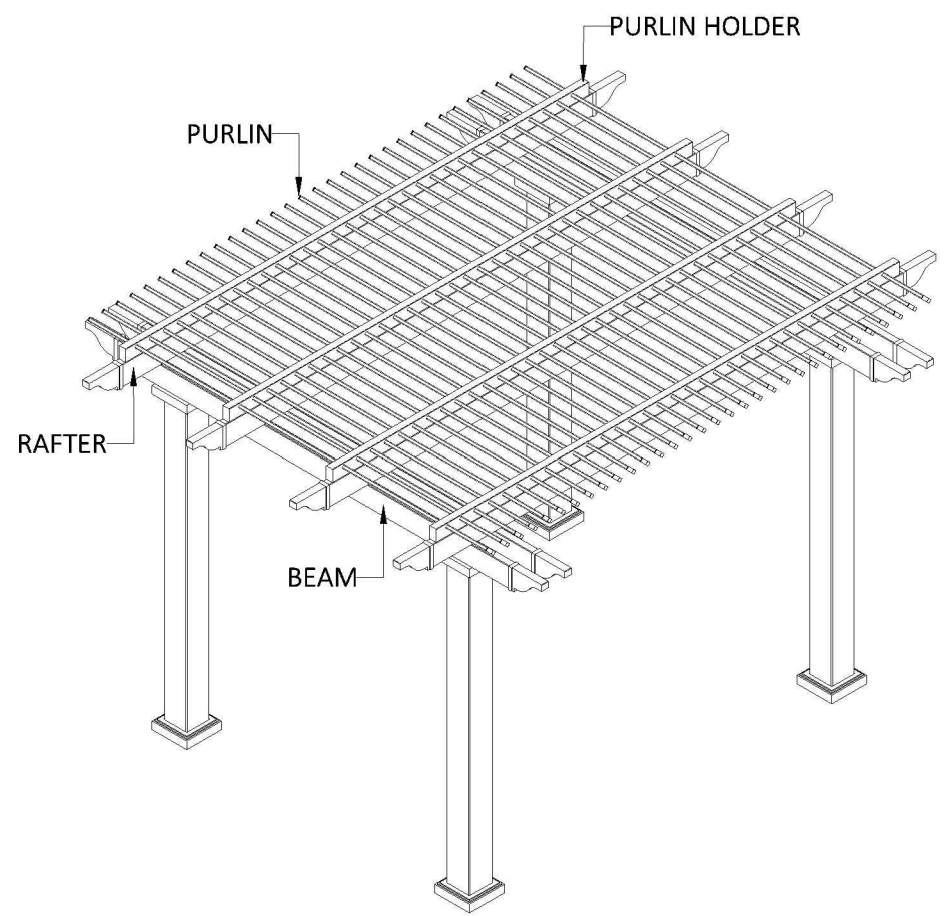
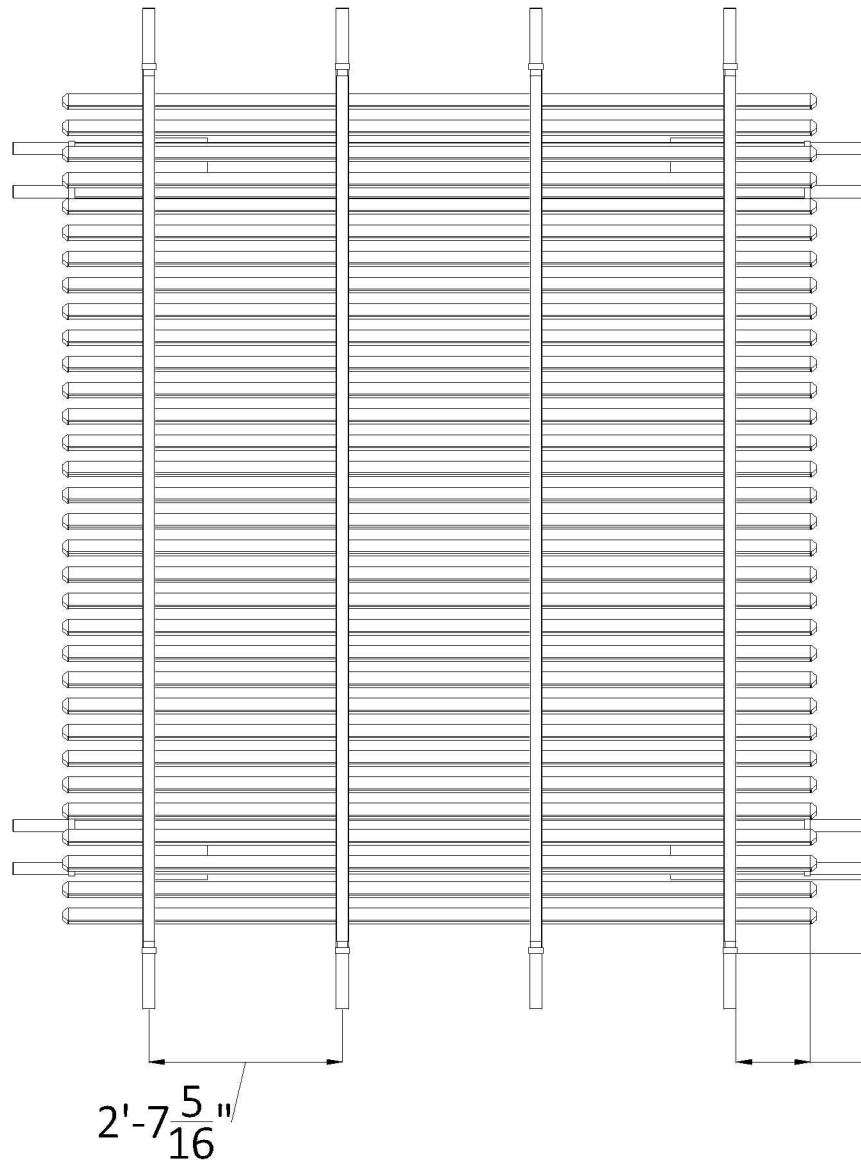

1' RAFTER
OVERHANG

1' PURLIN
OVERHANG

KIT COMPONENTS

DESCRIPTION	QUANTITY
Your Selected Post with Aluminum Insert	4
2 X 6 Beam with Aluminum Insert	4
2 X 6 Rafter with Aluminum Insert	4
2 X 6 Pergola Cap	16
2 X 3 1/2 Purlin Holder	4
2 X 3 1/2 Flat Cap	8
7/8 X 3 Purlin (75% Shade)	34
7/8 X 3 Purlin Cap	68