

FRONT ELEVATION

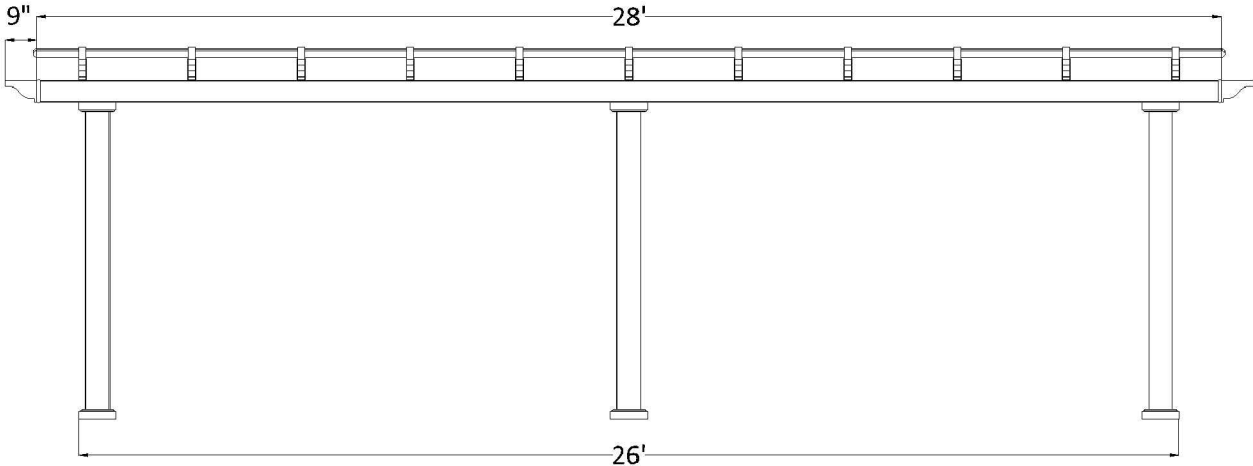

POST ON CENTER MEASUREMENT FOR THREE POSTS

POST STYLE	INCHES
5" Square Post (7" base)	153 1/2
7" Square Column (10 1/2" base)	150 3/4
7" Round Column (10 1/2" base)	150 3/4
10" Round Column (12 1/4" base)	149 7/8

SIDE ELEVATION

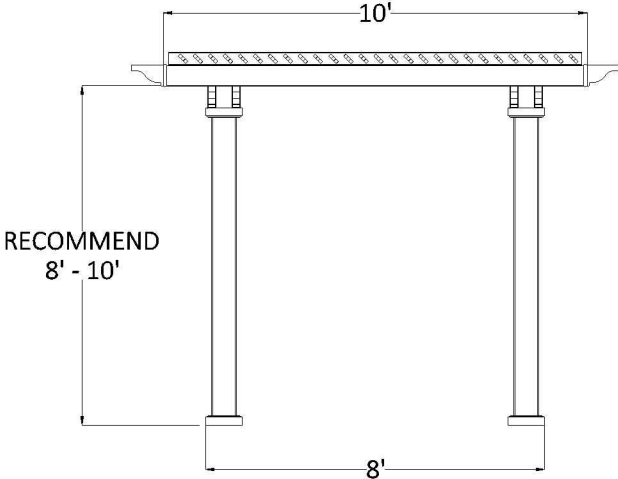

POST ON CENTER MEASUREMENT

POST STYLE	INCHES
5" Square Post (7" base)	91
7" Square Column (10 1/2" base)	85 1/2
7" Round Column (10 1/2" base)	85 1/2
10" Round Column (12 1/4" base)	83 3/4

PLAN VIEW

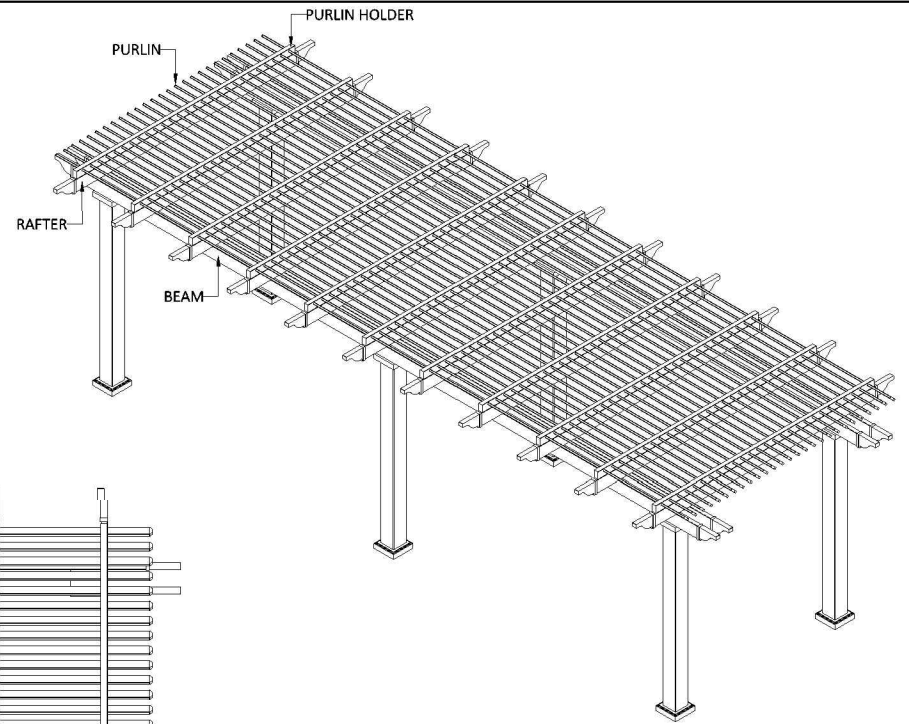
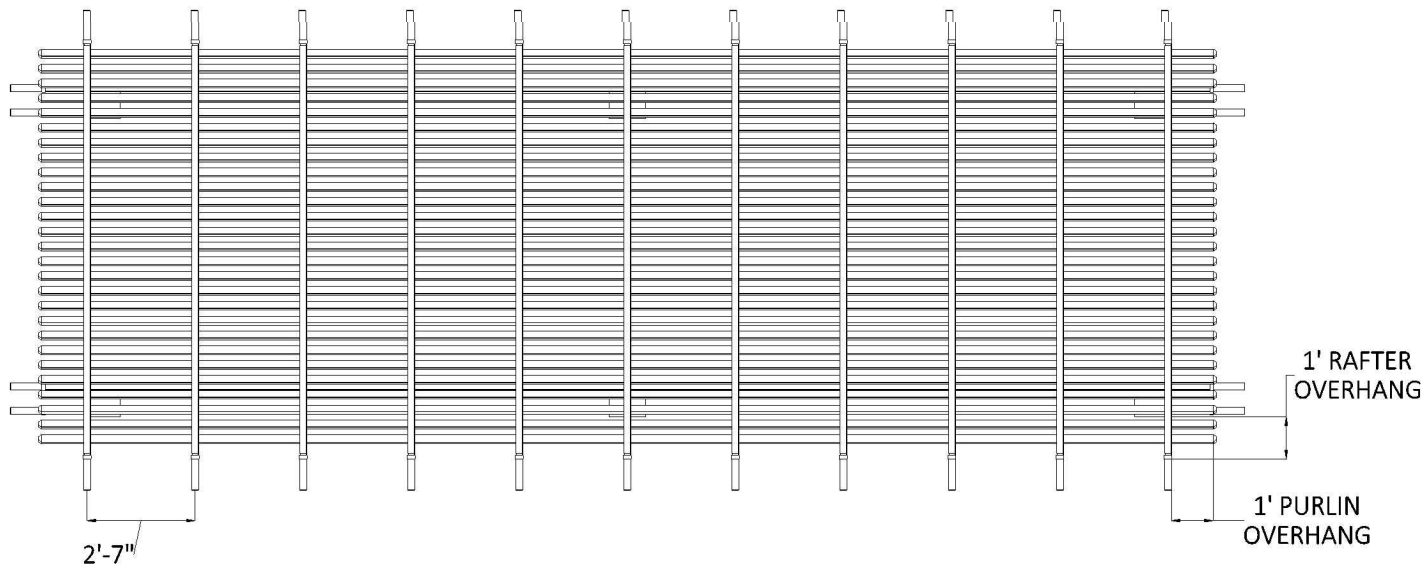

KIT COMPONENTS

DESCRIPTION	QUANTITY
Your Selected Post with Aluminum Insert	6
2 X 6 Beam with Aluminum Insert	8
2 X 6 Rafter with Aluminum Insert	11
2 X 6 Pergola Cap	30
2 X 3 1/2 Purlin Holder	11
2 X 3 1/2 Flat Cap	22
7/8 X 3 Purlin (75% Shade)	28
7/8 X 3 Purlin Cap	56