

FRONT ELEVATION

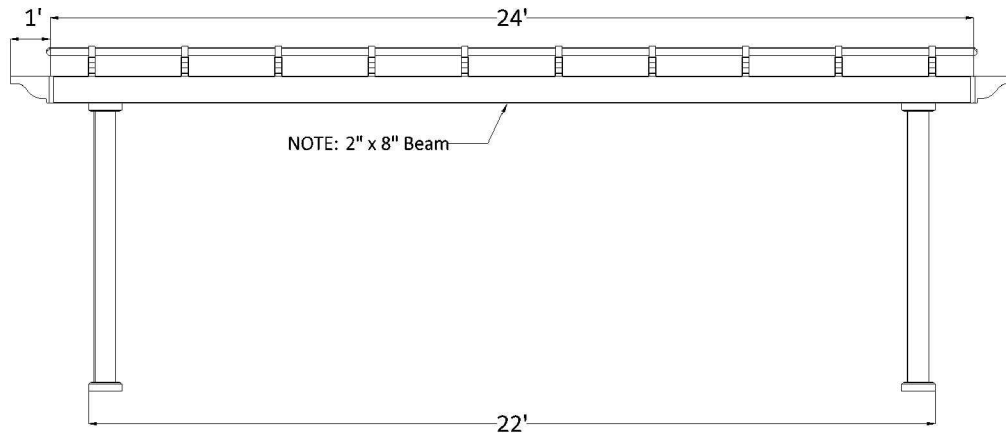

SIDE ELEVATION

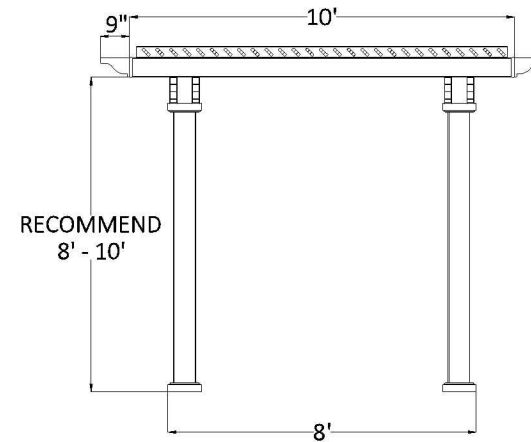

POST ON CENTER MEASUREMENT

POST STYLE	INCHES
5" Square Post (7" base)	259
7" Square Column (10 1/2" base)	253 1/2
7" Round Column (10 1/2" base)	253 1/2
10" Round Column (12 1/4" base)	251 3/4

POST ON CENTER MEASUREMENT

POST STYLE	INCHES
5" Square Post (7" base)	91
7" Square Column (10 1/2" base)	85 1/2
7" Round Column (10 1/2" base)	85 1/2
10" Round Column (12 1/4" base)	83 3/4

PLAN VIEW

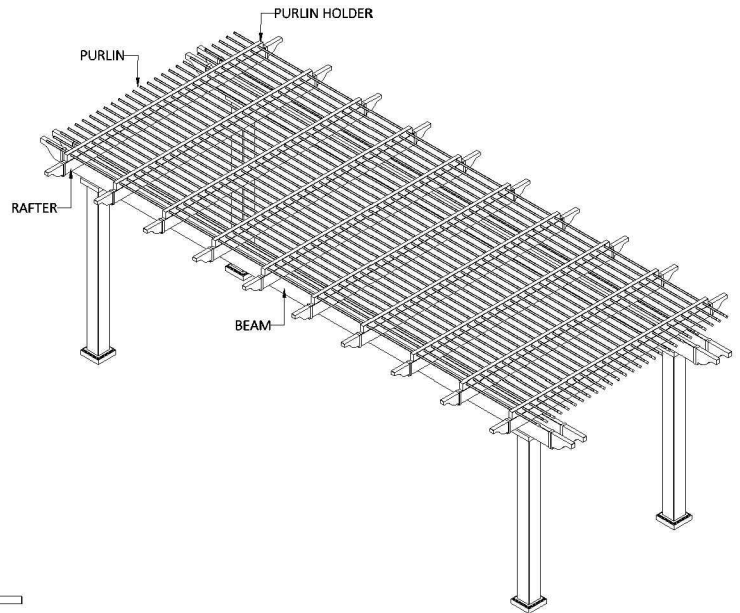
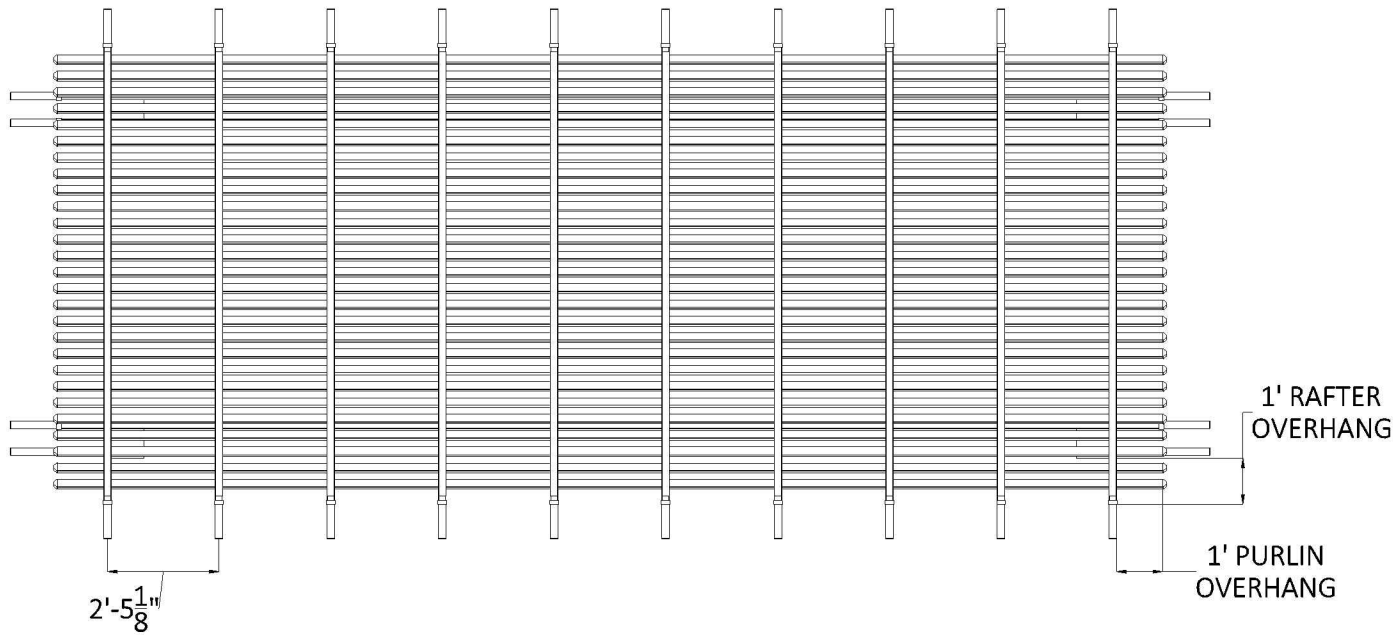

KIT COMPONENTS

DESCRIPTION	QUANTITY
Your Selected Post with Aluminum Insert	4
2 X 8 Beam with Aluminum Insert	4
2 X 6 Rafter with Aluminum Insert	10
Pergola Cap	28
2 X 3 1/2 Purlin Holder	10
2 X 3 1/2 Flat Cap	20
7/8 X 3 Purlin (75% Shade)	28
7/8 X 3 Purlin Cap	56