

FRONT ELEVATION

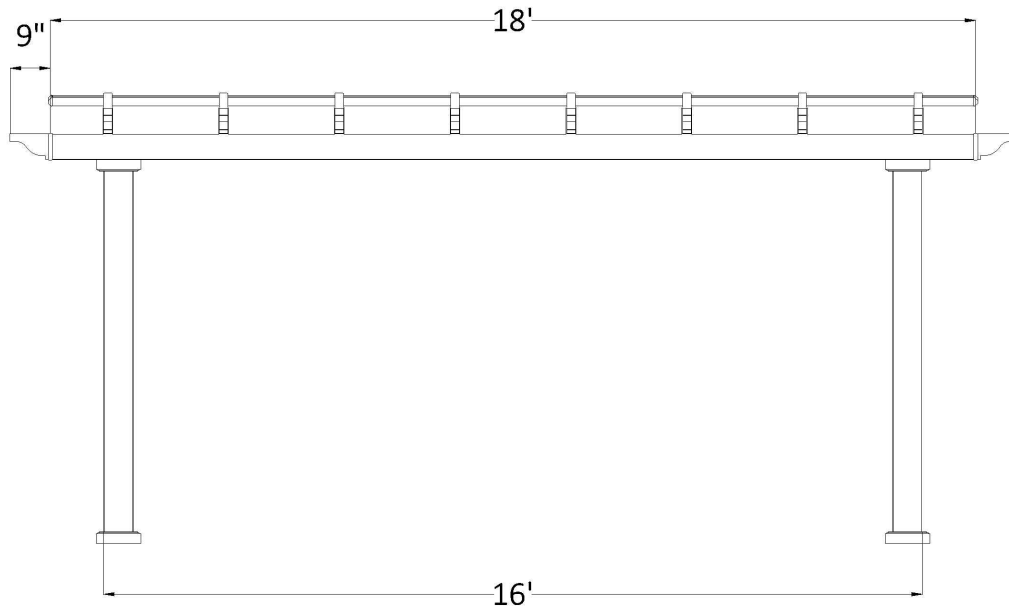

Post On Center Measurement

5" Square Post	187"
7" Square Column	181 1/2"
7" Round Column	181 1/2"
10" Round Column	179 3/4"

SIDE ELEVATION

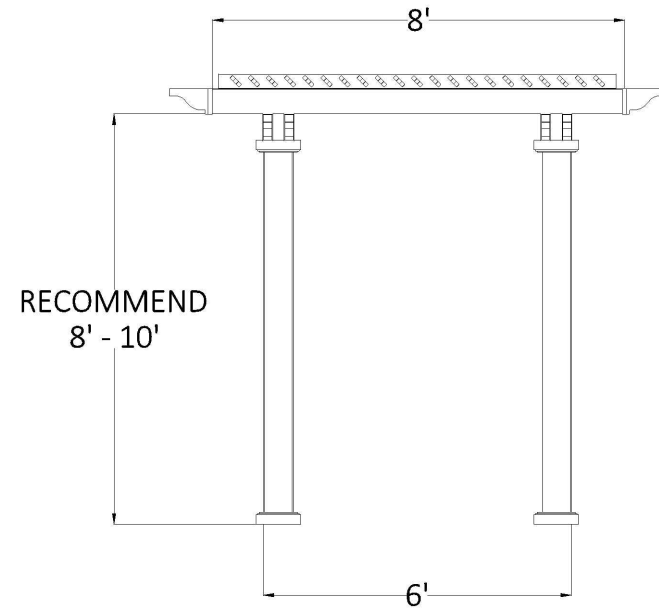

Post On Center Measurement

5" Square Post	67"
7" Square Column	61 1/2"
7" Round Column	61 1/2"
10" Round Column	59 3/4"

PLAN VIEW

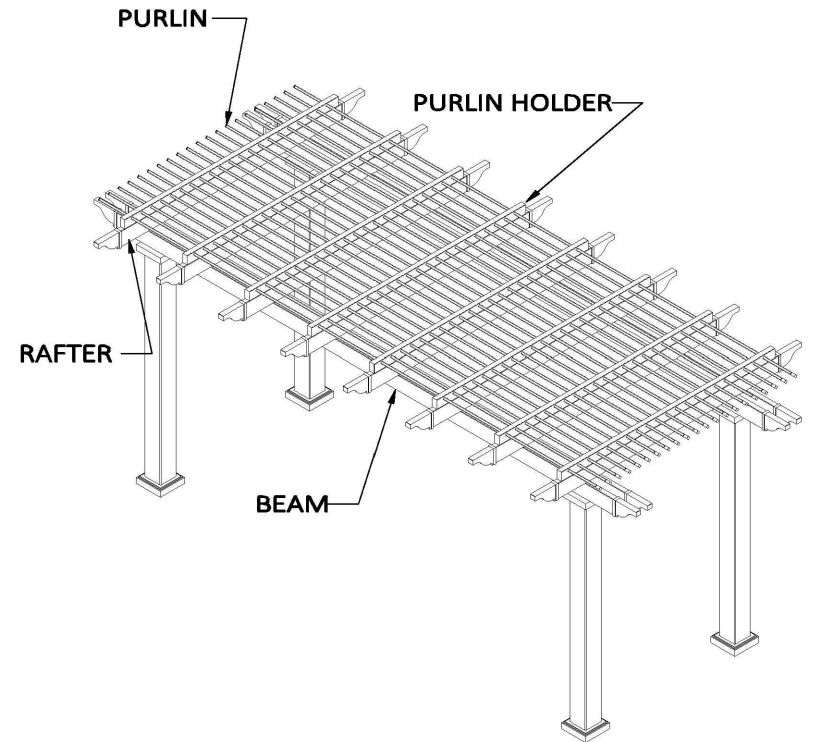
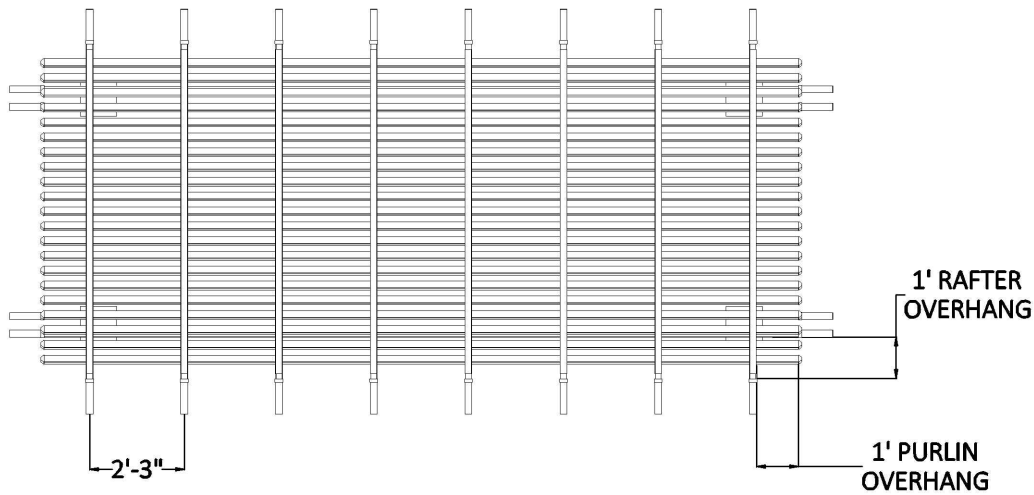

STRUCTURAL COMPONENTS

DESCRIPTION	QTY.
7" COLUMN ASSEMBLY W POST MOUNT	4
2 X 6 BEAM WITH ALUMINUM INSERT	4
2 X 6 RAFTER WITH ALUMINUM INSERT	8
2 X 6 PERGOLA CAP	24
2 X 3 1/2 PURLIN HOLDER	8
2 X 3 1/2 FLAT CAP	16
7/8 X 3 PURLIN (STD SPACING)	21
7/8 X 3 PURLIN CAP	42